

INSTALLATION AND OPERATING INSTRUCTIONS

Nanoe Generator

Model No. FV-15CSD1

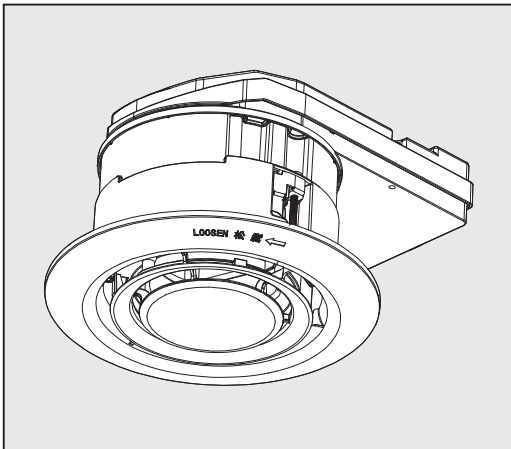

CONTENTS

SAFETY INSTRUCTIONS	2
INSTALLATION INSTRUCTIONS	2~3
INSTALLATION REQUESTS.....	3
SUPPLIED ACCESSORIES.....	4
PARTS NAME AND DIMENSIONS.....	4
HOW TO INSTALL.....	4~5
TEST RUN.....	6
USE AND MAINTENANCE INSTRUCTIONS.....	6~7
TROUBLESHOOTING.....	7
FURTHER INFORMATION....	7~BACK COVER
SPECIFICATIONS.....	BACK COVER

Warranty card attached

Thank you for purchasing this Panasonic product.

Please read these instructions carefully before attempting to install, operate or service the Panasonic product. Please carefully read "INSTALLATION INSTRUCTIONS" (P.2~3) of this instructions before installation. Failure to comply with instructions could result in personal injury or property damage. Please explain to users how to operate and maintain the product after installation, and this booklet should be presented to users. Please carefully read "USE AND MAINTENANCE INSTRUCTIONS" (P.6~7) of this instructions before operation. Please retain this booklet for future reference.

Make sure that the correct information is written on the warranty card, including the date of purchase and the name of the distributor. Keep the warranty card in a safe place along with the instructions for future reference.

SAFETY INSTRUCTIONS

Please observe strictly

- Disconnect power supply before maintenance.
- If the supply cord is damaged, it must be replaced by a special cord or assembly available from the manufacturer or its service agent.
- This product is not intended for use by persons (including children) with reduced physical, sensory or mental capabilities, or lack of experience and knowledge, unless they have been given supervision or instruction concerning use of the product by a person responsible for the safety. Children should be supervised to ensure that they do not play with the product.

The following instructions should be strictly observed in order to prevent injury to the users and other people, or damage to property.

- The degrees of injury or damage that can occur when the instructions are ignored and if the product is not used properly have been classified and described by the following indications.



WARNING

This indication means: Must be treated seriously that this may result in death or serious injury.



CAUTION

This indication means: Must be treated seriously that this may result in injury or physical damage.

- Types of instructions that should be observed have been classified and described by the following pictorial symbols.



This symbol indicates the item is "PROHIBITED" to do.



This symbol indicates the "COMPULSORY" item that must be followed without failure.



This symbol indicates the item is "CAUTION".

INSTALLATION INSTRUCTIONS



WARNING

- The product must be grounded.



Otherwise, it may cause electric shock when there is any trouble or electric leakage.

- Don't operate the product other than the rated voltage (220 V-240 V~ 50 Hz).



Otherwise, it may cause damages to the product or a fire.

- Please install an all-pole switch which the contact separation is more than 3 mm to control the power of the product.



Otherwise, it may cause a short circuit, thus resulting a fire.

- The power cord must be fixed to lower than cord exit.

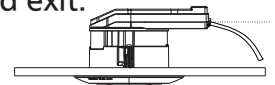

Water may flow into product through the power cord, which will cause electric shock or result in fire.

- Don't install the product with the method which is not approved in the instructions.



Otherwise, unreliable installation may be caused and thus the product may fall off, resulting in injuries.

INSTALLATION INSTRUCTIONS

⚠ WARNING

- This product must be installed by qualified technician.

⚠ Improper installation may cause the product to fall off.

- Installation regulation concerning local requirement should be fulfilled.

⚠ This may damage the product's structure and decrease its safety.

⚠ CAUTION

- Product must be installed tightly.

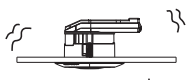

Otherwise, product may fall off to cause personal injury.

- Components must be installed tightly.



⚠ Otherwise, components may fall off to cause personal injury.

- Do not install the product on the window or wall.



Otherwise, product may fall off to cause personal injury.

- Do not install the product where is exposed to oil mist.



Otherwise, short circuit may result in fire.

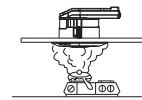

- Do not reconstruct this product.



Otherwise, it may cause damage to the product.

INSTALLATION REQUESTS

- Do not install the product in places with high temperature.

Otherwise, it may cause the product deformation or the motor life shorten.

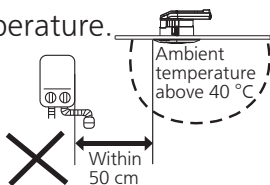

- Do not install product on a slanting ceiling.

Otherwise, it may cause the product abnormal.

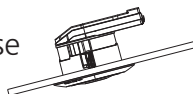

- Use a wall switch (supply on market) as the power switch for product (Turning ON/OFF to control the product).

- Install the product over 1.5 m apart from the fire annunciator. Otherwise it may cause false action of the fire annunciator. For detail, please confirm the fire annunciator instructions.

- Do not install product where is exposed to humidity.

Otherwise, it may cause the product abnormal.

- Install the product at the position as the figure show below.

Above 150 mm

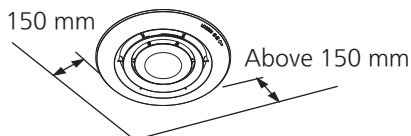

Above 150 mm

Otherwise, it may cause the wall dirty.

- Suggest to install the product over 1.5 m apart from the vent.

Otherwise, it may affect the performance of the product.

SUPPLIED ACCESSORIES

The following accessories are provided with the product in the package. When you unpack, check if the accessories are all included. If not, please contact your dealer.

No.	Drawing	Name	Qty
①		Installation and operating instructions	1
②		Warranty card	1

PARTS NAME AND DIMENSIONS

Unit: mm

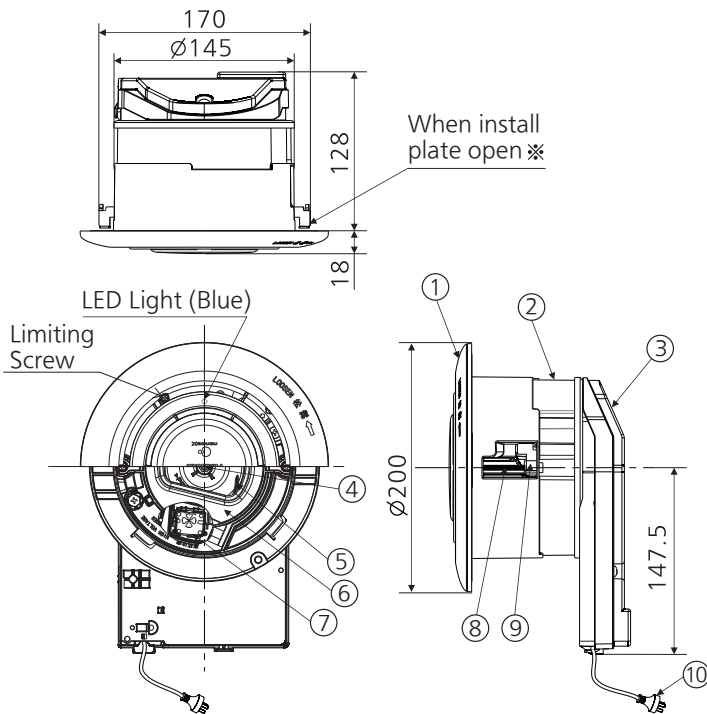

No.	Part name	Qty
①	Louver	1
②	Frame	1
③	Electric Case Assy	1
④	Motor	1
⑤	Fan	1
⑥	Orifice Assy	1
⑦	nanoe™ X unit	1
⑧	Install Screw	2
⑨	Install Plate	2
⑩	Power plug	1

* Initial position of install plate is closed.

HOW TO INSTALL

① Take off the limiting screw, turn the louver along the arrow to take it out.

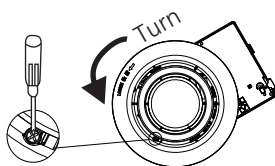

② Ensure each install plate is at the initial position (shown as below) and insert product into ceiling inclined.

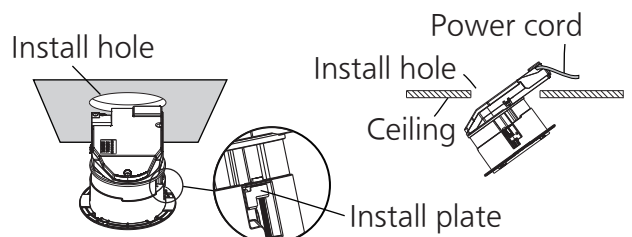

HOW TO INSTALL

- ③ Turn the install screw of product clockwise till the install plate clamping to ceiling.

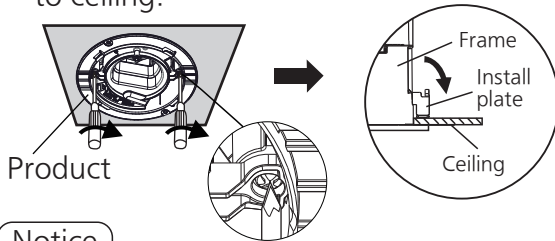

Notice

Ensure the tighten torque in the range of 60 cN·m to 120 cN·m. Product may fall off when torque not enough, may damage when torque too large.

- ⑤ Turn the louver until "▽" align to "↑" of product and it sounds "Da" means locked.

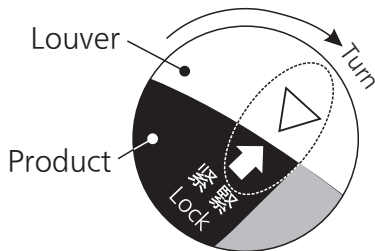

- ④ Find the "▽" mark on louver, place louver to product aligning the "▽" to "△" on product.

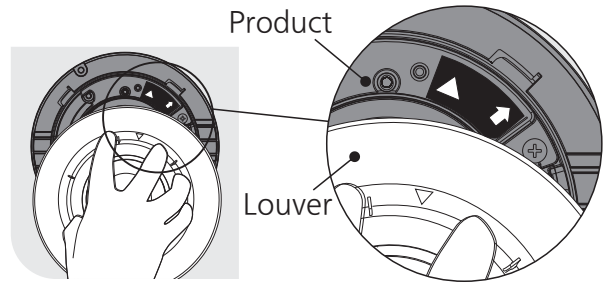

- ⑥ Fix the limiting screw.

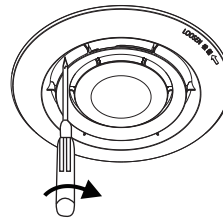

Notice

Ensure the tighten torque in the range of 20 cN·m to 40 cN·m. Product may fall off when torque not enough, may damage when torque too large.



CAUTION

- Keep the louver close to the ceiling.

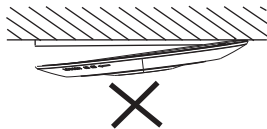

Parts may fall off and result in injury.

TEST RUN

Please check the following items by test run after connecting power.

- Does the fan rotate?
- Does the blue LED light light?
- Does it have abnormal vibration or noise?

USE AND MAINTENANCE INSTRUCTIONS

WARNING

- Do not inspect and maintain the product by unqualified persons.

 Otherwise, it may cause electric shock or personal injury.

- Before touching the product, ensure that the power switch is turned off.

 Otherwise, it may result in electric shock.

- Once flammable gas leaks, do not start any function of this product.

 Otherwise, it may generate spark and thus lead to explosion.

- Do not spray or clean this product directly with water or other liquid.

 Otherwise, it may cause short circuit or electric shock.

- The fan may rotate even when power supply is switched off. Please make sure the fan has been stopped before inspection.

 Otherwise, it may cause injury if finger or object is caught into the rotating section.

- If you will not use this product any more, remove the product.

 This product may cause injuries once it falls off.

- Do not disassemble this product for repair or reconstruction.

 Doing this may lead to fire and electric shock.

CAUTION

- When you check or clean the product, please wear gloves.

 Otherwise, it may result in personal injury.

- Do not insert the finger to the louver gap when cleaning the louver.

 Otherwise, it may result in personal injury.

Notice

1. According to the condition of using environment, routine maintenance is required at least once a year.
2. Do not immerse blade or other resin parts in hot water over 60 °C.
3. Do not use petrol, benzene, thinner or any other such alkaline detergent for cleaning the product.



USE AND MAINTENANCE INSTRUCTIONS

- Clean the dust on surface of louver with a cloth adding neutral cleanser, and then dry the louver with a soft dry cloth.

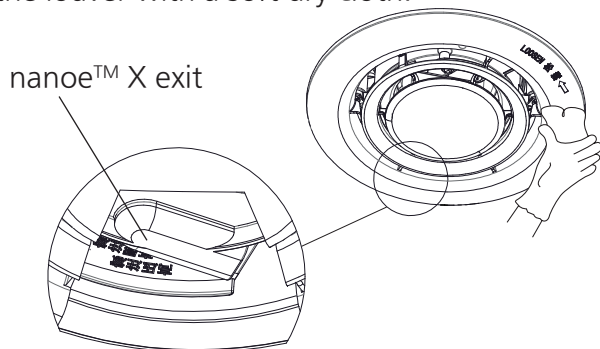

- ⊘ Do not insert the finger or rarity into the nanoe™ X exit. Otherwise, it may cause short circuit or electric shock.

TROUBLESHOOTING

Check the product according to the table below if a fault occurs. If the error still occurs, disconnect all-poles switch of the product, and contact your dealer.

Symptom	Cause	Troubleshooting
<ul style="list-style-type: none"> • Fan doesn't rotate • No wind blows out • Running LED light (blue) doesn't light 	Switch is off	Turn the switch on
	Incorrect wiring	Contact your dealer
Smells peculiarly	When nanoe™ X is generated, small amount of ozone will be release. However, it will be not harmful to human beings	It is the performance when product is normally running, not function abnormal
Sounds "zi" lightly around the orifice	The sound comes with nanoe™ X generating. It is hard to detect it	It is the performance when product is normally running, not function abnormal
LED light (blue) blinks	The product is in abnormal	Contact your dealer
Abnormal shaking or noise	Failure installation of louver or product abnormal	Contact your dealer

FURTHER INFORMATION (About nanoe™ X)

Generating environment

- nanoe™ X is generated using the air in the room and hence, depending on the temperature and humidity, there can be incidences whereby nanoe™ X is not stably generated.
- Conditions for generated
 - Room temperature: About 5 °C~40 °C (dew-point temperature: more than 2 °C)
 - Relative humidity: About 30%~85%

Small amount of ozone will be generated

- When nanoe™ X ion is generated, small amount of ozone will be release. However, the quantity will be less than the usual level in forest or natural environment, and not harmful to human beings.

FURTHER INFORMATION (About nanoe™ X)

About nanoe™ X

- The so-called nanoe™ X are particulate ions containing hydroxyl radicals whose amount is 10 times that of nanoe™.
- nanoe™ X are charged water purification particles generated by applying high voltage to separate water molecules.
- nanoe™ X features: high moisture content, small particles, stability.
 1. High moisture content (the moisture content is 1,000 times the moisture content of ordinary anions)
 2. Small particles (about 5 nm - 20 nm in size)
 3. Stability (nanoe™ X has a 6 times higher stability than an ordinary anions, with a 10-meter or longer range of coverage)
 4. High OH hydroxyl amount (up to 4,800 billion of OH ions are generated per second)
 5. Weak acidity (with weak acidity features close to that of hair and skin)



Note: nanoe™ and the nanoe™ mark are trademarks of Panasonic Corporation.

SPECIFICATIONS

Rated Voltage [V]	Rated Frequency [Hz]	Power Consumption [W]	Air Volume [m³/h]	Noise [dB(A)]	Net weight [kg]
220	50	4.0	15	23.5	1.3
230	50	4.0	16	25.5	
240	50	4.0	17	27	

- Value of power consumption, Air volume and noise are measured when the static pressure is 0 Pa.
- Air volume is the central value measured by this company with a range of ±10% tolerance.
- Noise is the A weighted sound pressure level, which is the central value measured by this company, its tolerance range is from +3 dB to -7 dB. The method to measure is as follows: in an anechoic chamber, measure noise value 1 m away from the front, left and beneath of the product, then get the average value.
- The applicable ambient temperature of this product is in the range of -10 °C~40 °C, using it out of this range may cause a fault. However, please see page 7 for the generating environment of nanoe.
- This product comply with the IPX2 requirement against the water drop experiment.
 - * The above specification may be changed without prior notice.